



















Solder pads  
Don't touch

-  16mm c/c, Ø2mm  
VERONICA-SQ-MINI
  -  21.5mm c/c, Ø2mm  
VERONICA-SQ-MINI  
(GABRIELLA-MIDI-HLD)  
(SURI)
  -  13.6mm c/c, Ø2mm  
GABRIELLA-MIDI-LENS  
GABRIELLA-45-LENS  
SURI
  -  20X16.6mm c/c, Ø2.3mm  
FLARE
  -  21.5mm c/c, Ø2mm  
(VERONICA-SQ)
  -  35mm c/c, Ø3mm  
GABRIELLA-45-HLD
  -  21.52mm c/c, Ø2mm  
GABRIELLA-MIDI-HLD  
SURI
  -  15mm c/c, Ø2mm  
ROSE-MRK  
G2-ROSE-UV
  -  21.52mm c/c, Ø2mm  
LEIA
  -  16mm c/c, Ø2mm  
IRIE
  -  15mm c/c, Ø2mm  
ROSE-MRK  
G2-ROSE-UV
- Screw holes

  -  35mm c/c, Ø3.5mm  
GABRIELLA-45-HLD
  -  25.4mm c/c, Ø3.4mm  
GABRIELLA-MIDI-HLD  
LEIA  
SURI  
(JENNY (pin))
  -  25.4mm c/c, Ø3.5mm  
(GABRIELLA-MIDI-HLD)  
(LEIA)  
(SURI)  
(JENNY (pin))

-  8.6mm c/c, Ø2mm  
BILLIE  
EMERALD  
EMMA  
EMILY  
FLARE-MINI  
HEIDI  
IRENE  
JULIA  
IRIS-XP-HLD
-  LARISA  
LAURA  
LEILA  
LISA2/3  
LOTTA  
REGINA  
RITA  
SIRI  
STRADA  
STRADELLA  
TINA1/2/3
-  21.52mm c/c, Ø2mm  
CRYSTAL  
EMERALD-MAXI  
EVA  
FLARE-MAXI  
KIKI  
OLGA  
YASMEEN-30  
VERONICA  
VERONICA-SQ
-  MINNIE-LT  
STRADA-SQ  
HB-SQ  
FLORENTINA-1

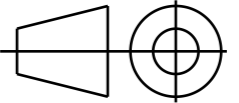
<b>MECHANICAL DRAWING</b>		
PRODUCT <b>46mm PCB</b>		
Plastic moulding general tolerances according to DIN 16901-130 and applies if not otherwise shown in the drawing. Silicone moulding general tolerances according to ISO 3302-1 Class M3 and applies if not otherwise shown in the drawing.	FIRST ANGLE PROJECTION: 	This drawing is the property of LEDiL Oy. It may not be copied or otherwise distributed without prior written permission from LEDiL Oy.
SCALE	4:1	WEIGHT -
		A3 SHEET 1/1